

# Istruzioni di montaggio **ARMADI ANTE SCORREVOLI**

## **Dimensioni modelli ante in vetro:**

Larghezze cm. 150/180

Profondità cm. 60

Altezze: cm. 85/150/200





3

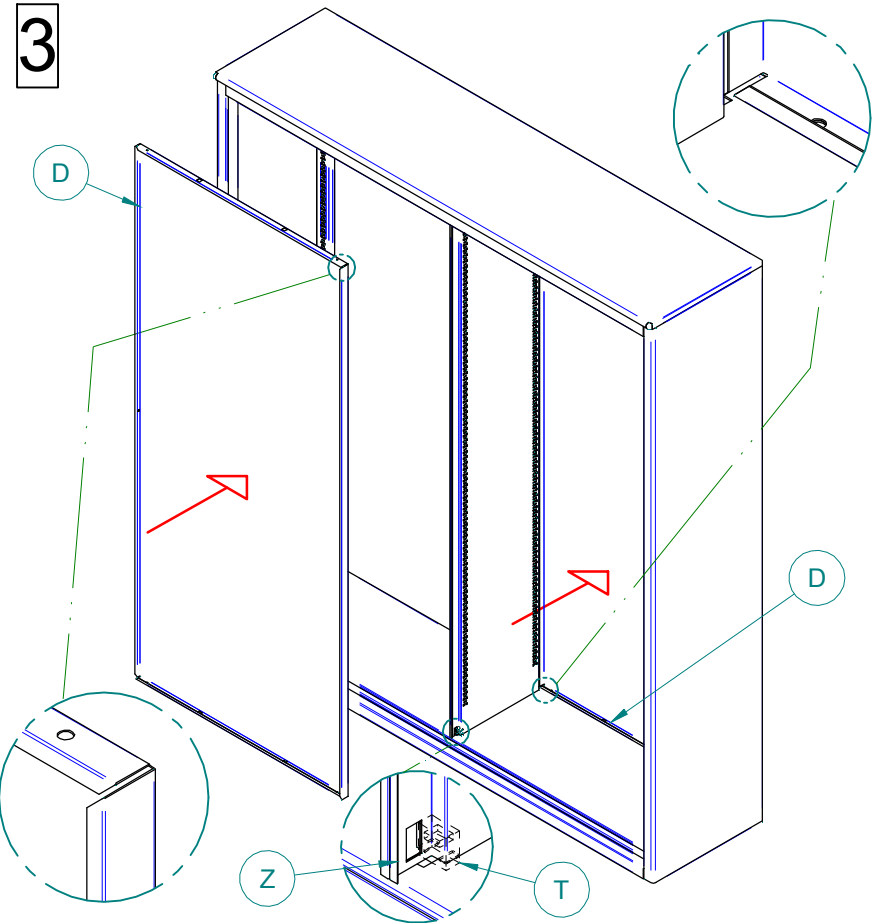

4

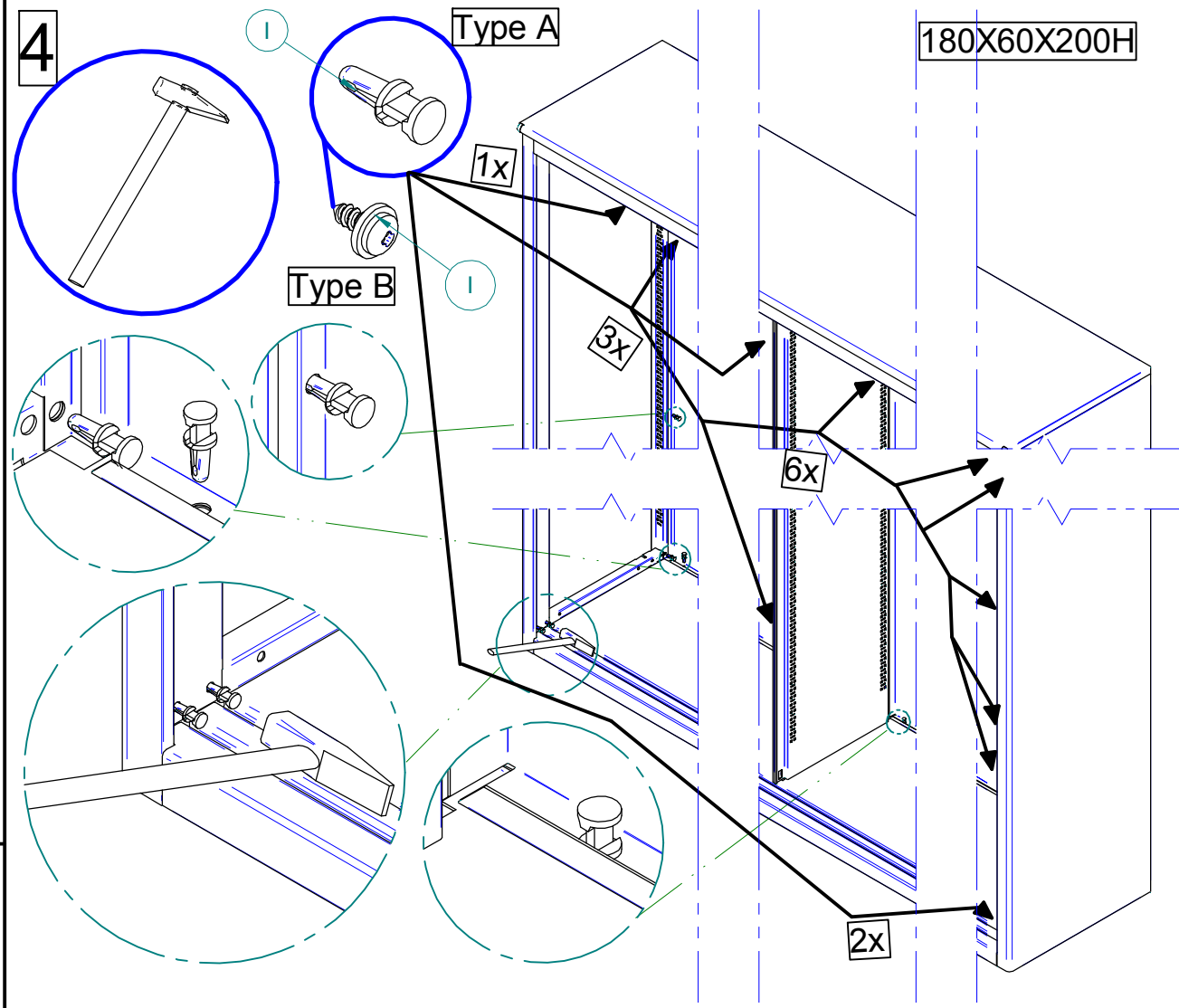

5

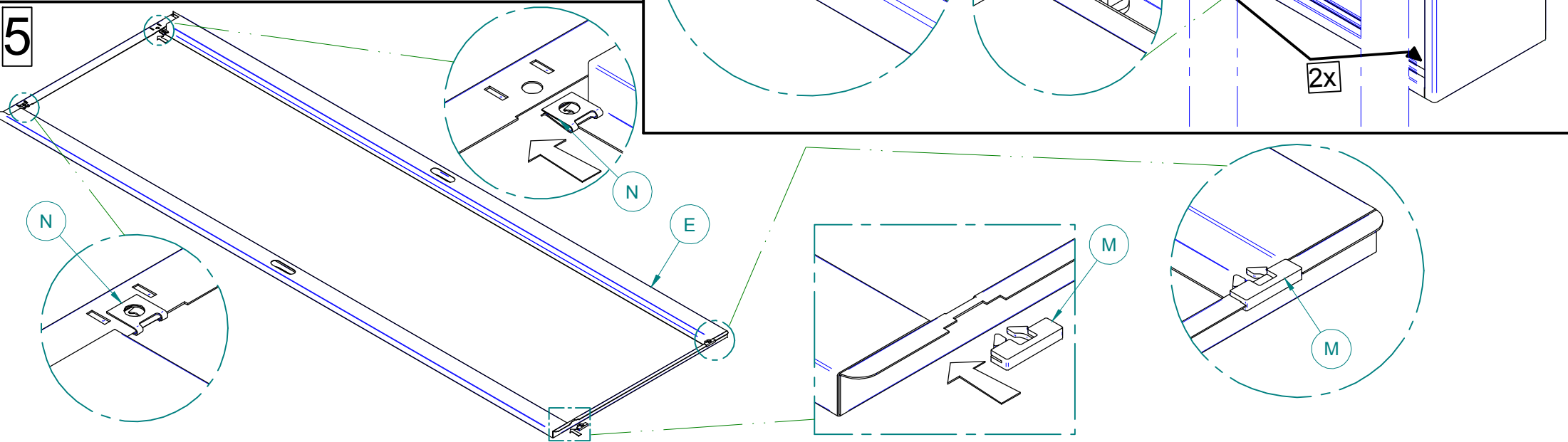

6

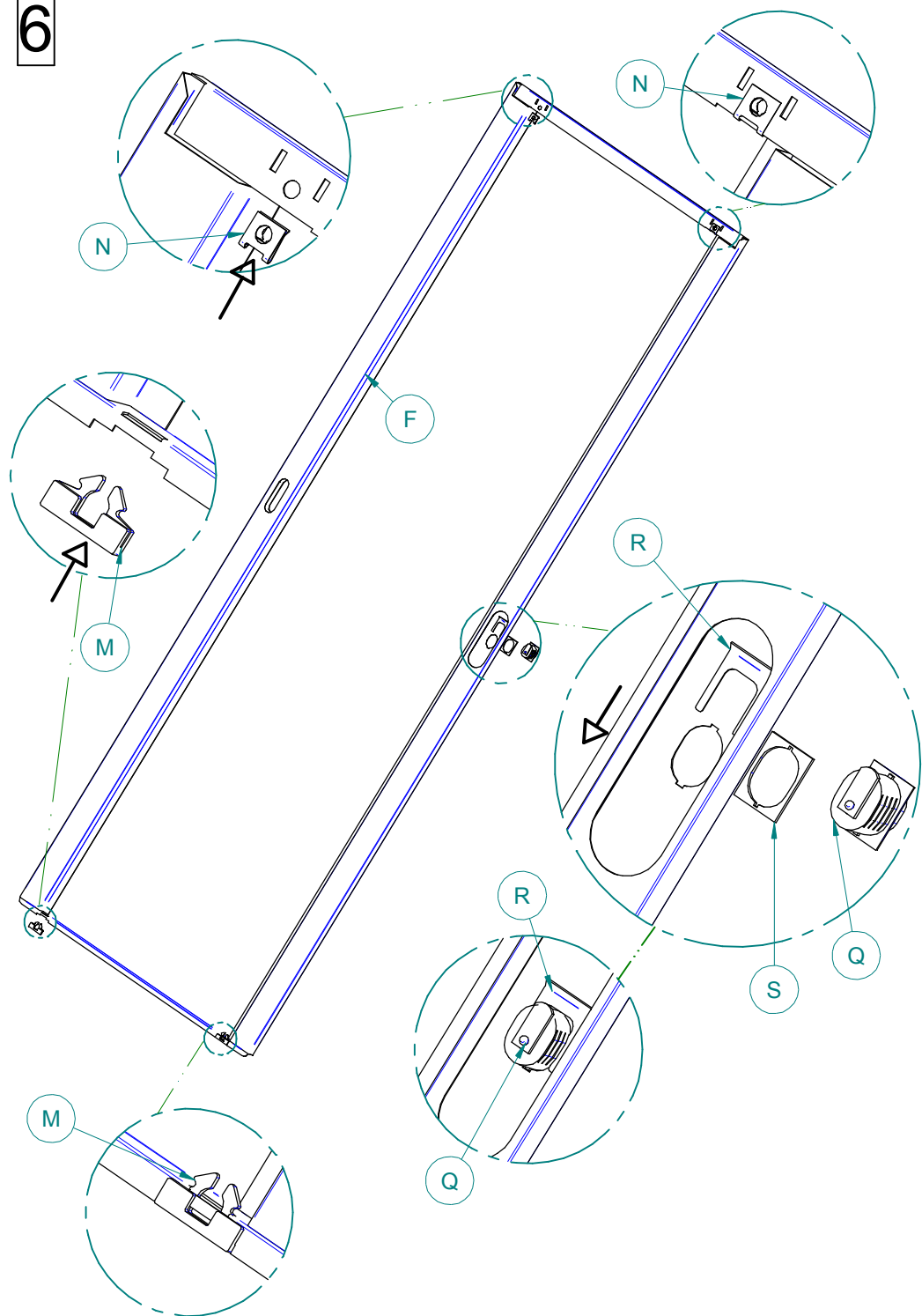

7

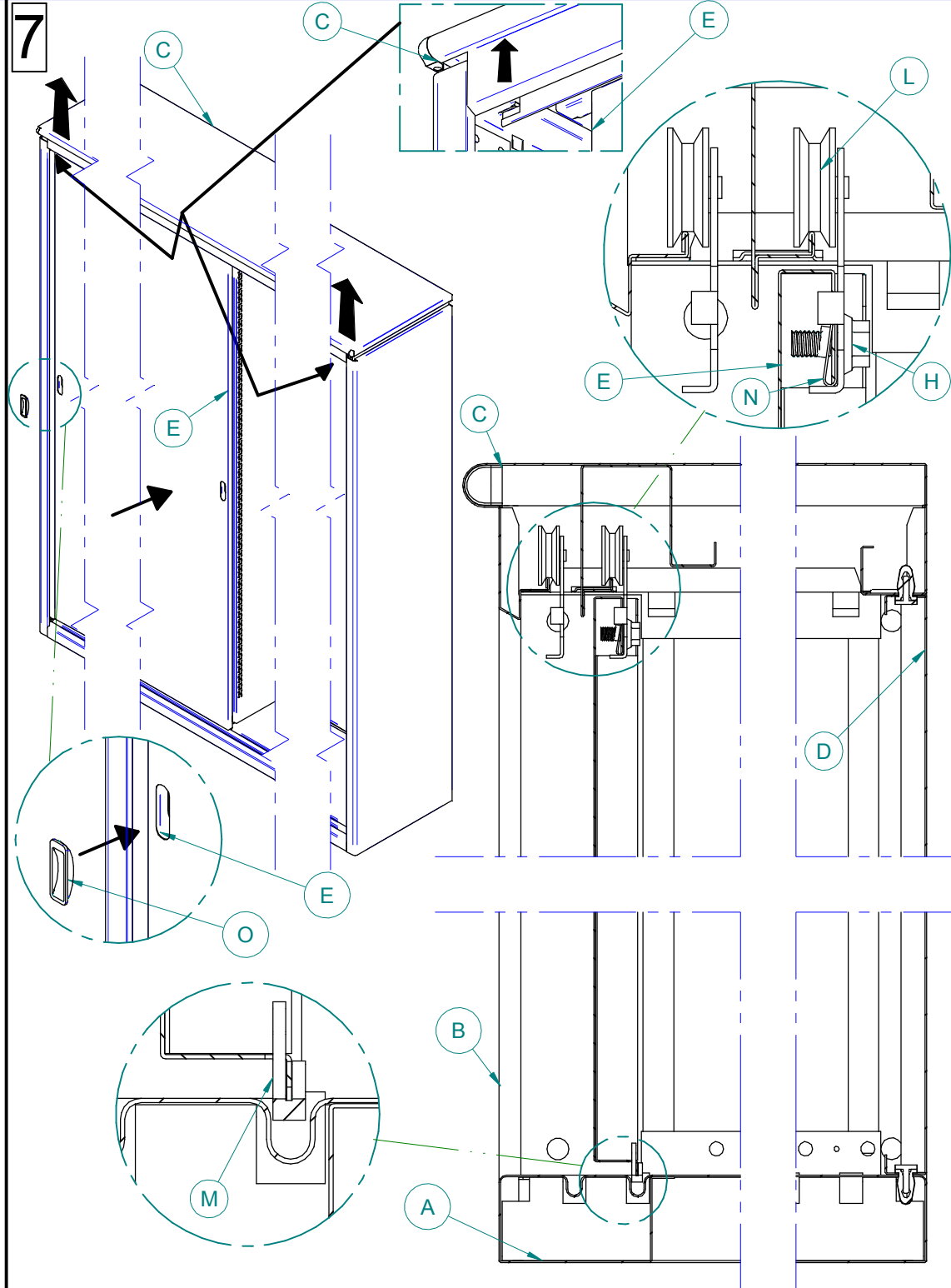

8

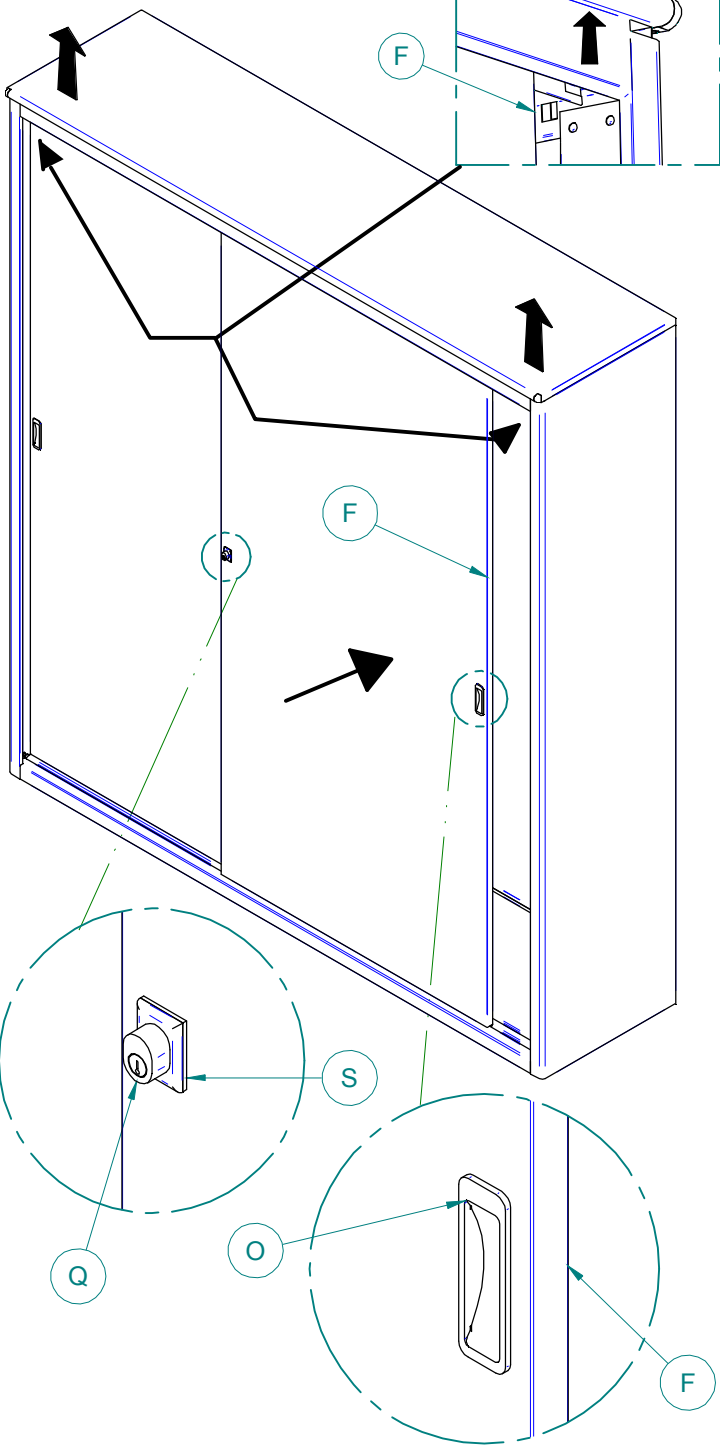

9

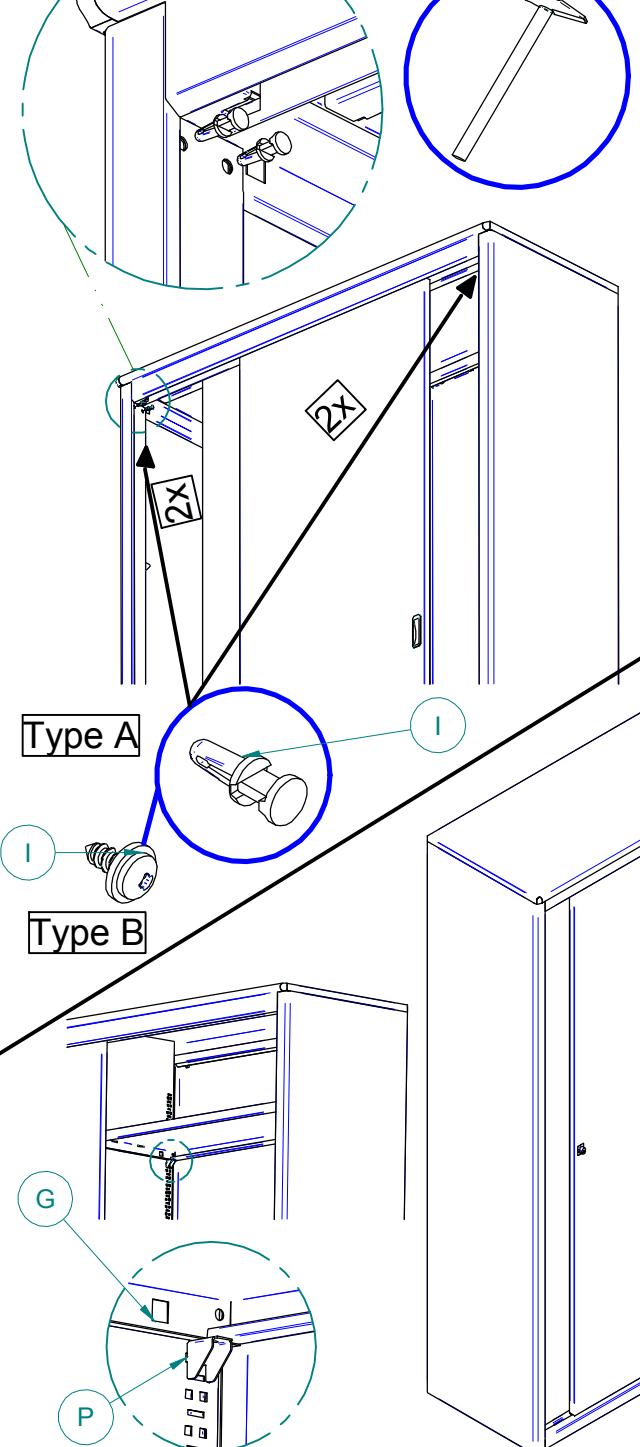

10

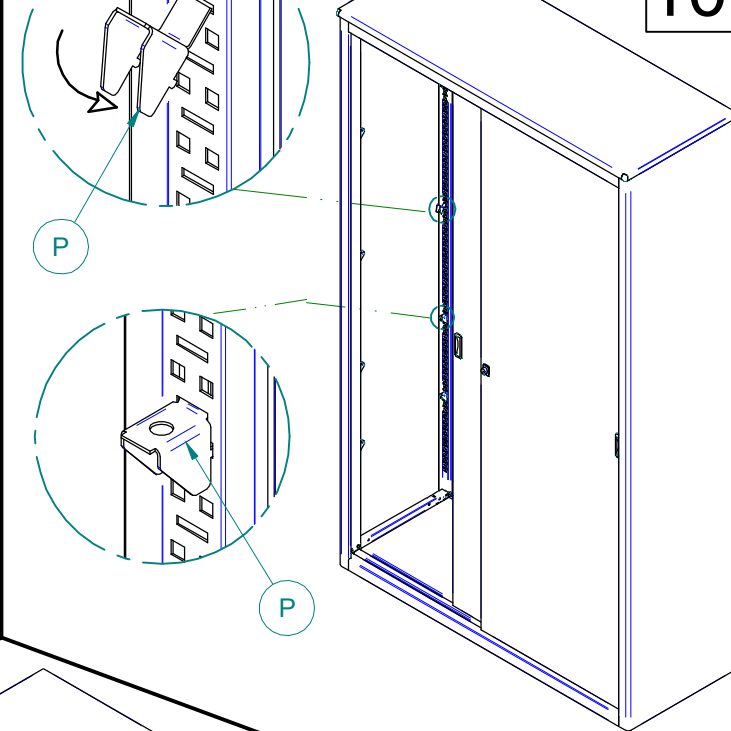

180 X 60 X 200H

11

